

Patented, Breveté, Patentato

MEGAMILL

The Only Helical Positive Indexable Cutter

L'unique Fraise Hélicoidale avec Coupe Positive

La Unica Fresa Hélicoidal con Corte Positivo

METRIC SERIES

Face Mill
Fraise à Surface
Fresa de Planear

90°

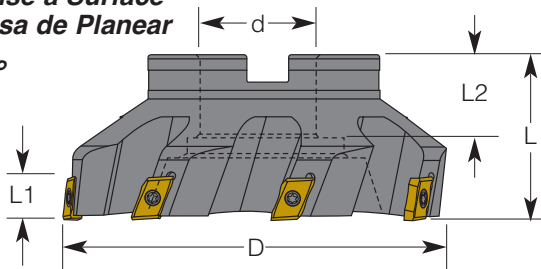

| TOOL NO. | DIMENSIONS IN MM | | | | | | NO. OF FLUTES | INSERTS NO.  |
|---------------|------------------|----|------|----|----|----|---------------|--|
| | D | d | L1 | L2 | L | Z | | |
| MMF-50900422 | 50 | 22 | 11.5 | 22 | 50 | 5 | CMSI-465 | |
| MMF-63900522 | 63 | 22 | 15.5 | 22 | 50 | 5 | CMSI-620 | |
| MMF-80900627 | 80 | 27 | 15.5 | 22 | 50 | 6 | CMSI-620 | |
| MMF-100900732 | 100 | 32 | 15.5 | 32 | 63 | 7 | CMSI-620 | |
| MMF-125900840 | 125 | 40 | 15.5 | 38 | 63 | 8 | CMSI-620 | |
| MMF-160900940 | 160 | 40 | 15.5 | 38 | 63 | 9 | CMSI-620 | |
| MMF-200901360 | 200 | 60 | 15.5 | 35 | 63 | 13 | CMSI-620 | |
| MMF-250901760 | 250 | 60 | 15.5 | 35 | 63 | 17 | CMSI-620 | |

Face Mill
Fraise à Surface
Fresa de Planear

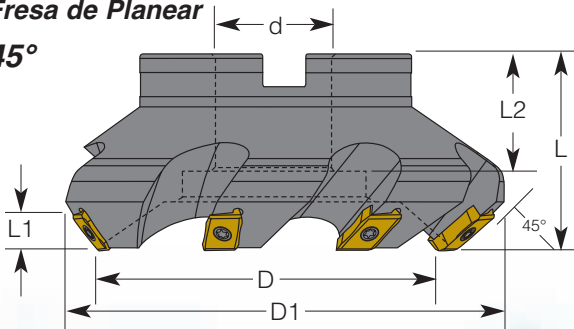

45°

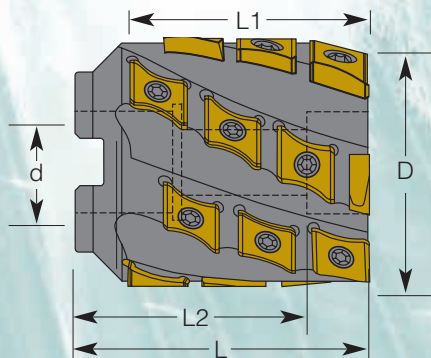

| TOOL NO. | DIMENSIONS IN MM | | | | | | | NO. OF FLUTES | INSERTS NO.  |
|---------------|------------------|----|------|----|----|-----|----|---------------|--|
| | D | d | L1 | L2 | L | D1 | Z | | |
| MMF-63450522 | 63 | 22 | 7.5 | 22 | 50 | 80 | 5 | CMSI-465 | |
| MMF-80450627 | 80 | 27 | 7.5 | 22 | 50 | 100 | 6 | CMSI-465 | |
| MMF-100450732 | 100 | 32 | 10.0 | 32 | 63 | 125 | 7 | CMSI-620 | |
| MMF-125450840 | 125 | 40 | 10.0 | 38 | 63 | 150 | 8 | CMSI-620 | |
| MMF-160450940 | 160 | 40 | 10.0 | 38 | 63 | 185 | 10 | CMSI-620 | |
| MMF-200451360 | 200 | 60 | 10.0 | 35 | 63 | 224 | 12 | CMSI-620 | |
| MMF-250451760 | 250 | 60 | 10.0 | 35 | 63 | 274 | 16 | CMSI-620 | |

Shell Mill



| TOOL NO. | DIMENSIONS IN MM | | | | | | NO. OF FLUTES | INSERTS NO. | | | |
|------------|------------------|----|----|----|-----|---|---------------|---|-----------|---|-----|
| | D | d | L1 | L2 | L | Z | |  | Qty |  | Qty |
| | | | | | | | | | | | |
| MMS-63534 | 63 | 27 | 53 | 55 | 73 | 4 | CMSI-620 | 10 | CMEI-687W | 2 | |
| MMS-80726 | 80 | 32 | 72 | 60 | 92 | 6 | CMSI-620 | 18 | CMEI-687C | 3 | |
| MMS-100826 | 100 | 40 | 82 | 66 | 102 | 6 | CMSI-620 | 24 | CMEI-687C | 3 | |